

**NEUMAG**

# **BCF carpet yarn solutions**

Innovation based  
on experience

From Melt to Yarn

A large industrial machine for BCF carpet yarn production, labeled 'BCF S8', is shown in a factory setting. The machine is primarily grey and black, with a prominent red roller at the bottom. Red laser lines are projected from various points on the machine, highlighting its complex internal mechanisms, including rollers, spindles, and control panels. The background shows a clean, modern industrial environment with large windows and structural beams.

# Your benefits

<b>From Melt to Yarn – Solutions along the textile value chain .....</b>	<b>4</b>
<b>BCF carpet yarn solutions with BCF S8 and BCF S+ .....</b>	<b>6</b>
<b>Key benefits</b>	
■ <b>Excellent product portfolio .....</b>	<b>8</b>
■ <b>Savings in OPEX .....</b>	<b>10</b>
■ <b>Innovative machine design .....</b>	<b>12</b>
■ <b>Product flexibility .....</b>	<b>24</b>
■ <b>Human-machine interface .....</b>	<b>30</b>
<b>Partnering for Performance .....</b>	<b>32</b>
<b>Our promises .....</b>	<b>34</b>





# From Melt to Yarn

## Solutions along the textile value chain

Place your business ideas in professional hands! Consulting, engineering, plant design, high-tech machinery and lifecycle management – the whole package from a single source. Many years of experience in textile machine construction and our strong global network form a solid basis and the perfect prerequisites for us as your solutions provider.

### Define your yarn properties from the very outset

From melt to fiber, from extrusion to BCF carpet yarn – we have your value-added chain under control. And you increase your profits. Because an optimized manufacturing process encompassing all production steps provides you with the greatest possible influence on the quality of your end product, and your production costs.

Add to this the fact that our brand strength will make financing your project a profitable investment.

Extensive experience in engineering and management competencies help us deliver even complex projects and processes. You can rely on that!

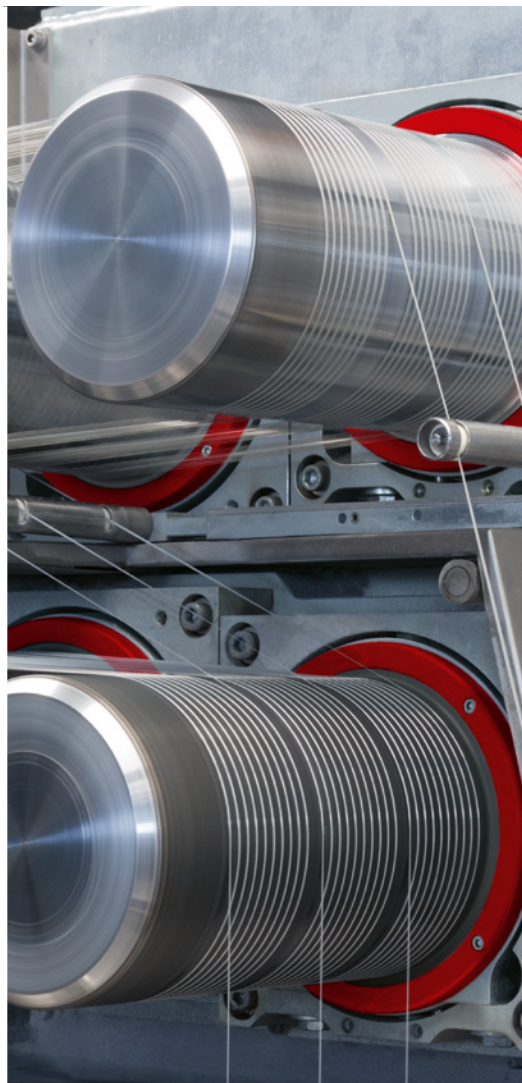

**ENGINEERING**

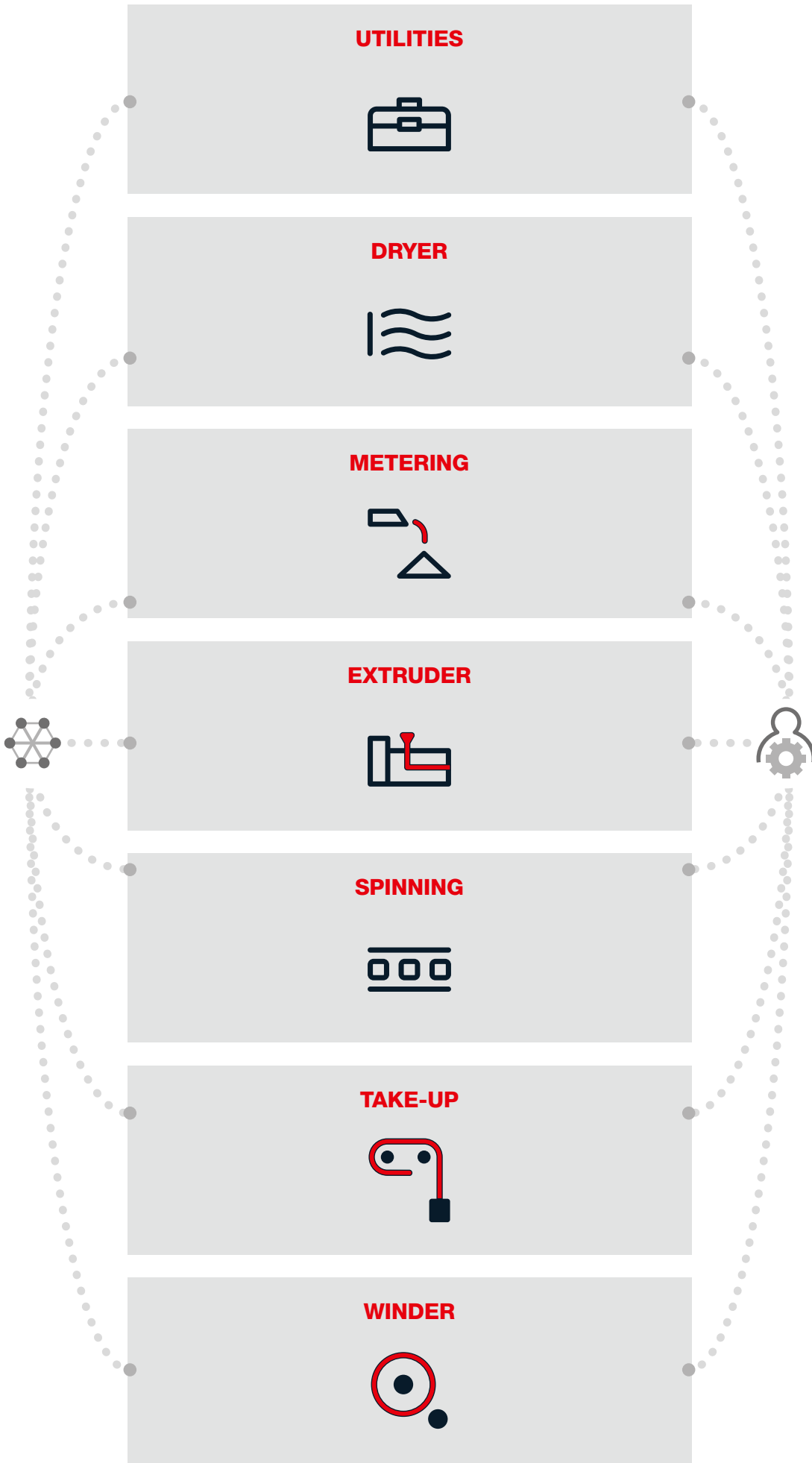

**CUSTOMER SERVICES**  
Consulting, Lifecycle Management, Technical Support

# BCF carpet yarn solutions with BCF S8 and BCF S+

Neumag has been supplying plants with 3 ends per position since 1974. Today, our 3-end technology is the most widely recognized in the world.

BCF carpet yarn manufacturers, whether producing commodity or niche products, are under increasing pressure for quality and efficiency. Our customers are looking for ways to improve the performance, quality and efficiency of their production processes.

## The idea

The Neumag BCF S8 plant is our most efficient BCF system to date. The BCF S8 offers high productivity and takes our product portfolio to a new level to help you compete in an ever-changing marketplace. Your success is very important to us. That is why we have further extended the straight yarn path from spinning to the draw field for an even better production process.

The most successful BCF system in the world is the BCF S+. The BCF S+ has been the proven platform for many BCF yarn applications and markets. Neumag development has reached the end of this technological platform. With the BCF S8, the next stage in BCF production has now begun. The BCF S+ is still the reliable workhorse for many applications.

**e-save**  
comprehensive efficiency

## e-save provides you with a competitive edge

With e-save, Barmag introduced a label for particularly energy-efficient systems, machines and components back in 2004. Over the past years, e-save has established itself as the trademark of a comprehensive efficiency program. This underlines the preeminent role of Barmag when it comes to commercial success and sustainability.

Compared to other concepts available on the market, our BCF plant solutions convince in terms of:

- Energy: BCF S8 adds an additional 5% to the energy saving of the highly efficient BCF S+ (with RoTac<sup>3</sup>)
- Economics: 99% efficiency at the highest production speeds
- Ergonomics: intuitive operation by trendsetting human-machine interface



## Leading innovation for the carpet industry

Neumag is one of the leading brands in the field of carpet yarn production. We provide tailored solutions for every scenario in the industry. With our cutting-edge BCF technology, we're your go-to partner for businesses worldwide!

### Your benefits:

- High opacity: Our BCF technology ensures excellent coverage, meeting the most demanding standards for carpet yarns.
- Maximized raw material utilization: Platforms that are designed for optimal raw material efficiency, minimizing waste and improving cost-effectiveness.
- Wide raw material compatibility: Capable of handling different raw materials, making them versatile and adaptable.
- Energy efficiency: Equipment conserves energy, reducing costs and impact.
- Highest flexibility: Solutions allowing manufacturers to adapt to changing market demands.
- Superior quality: Multiple innovations for a more reliable process and highest standards in yarn quality.
- Outstanding support: Outstanding support during the installation phase and throughout the entire life cycle of the machine.
- Future-oriented and economical: Solutions that help companies stay competitive in the global market.

### Your advantages:

	BCF S+	BCF S8
Polymer diversity	Yes	Yes
Yarn Quality	++	+++
Production speed	++	+++
System efficiency	up to 99%	up to 99%
Downstream efficiency	++	+++
Straight yarn path	+	+++
Process	3-end	3-end
Winder	Witras III-34	Witras III-34 and Witras III-37
e-save certified	Yes	Yes
HMI / Industry 4.0	+	+++
Variomelt (tricolor)	Yes	Yes
Color Pop Compacting (tricolor)	+	> 200.000 grades
BICO BCF	-	Yes (PET/PBT, PET/PTT)



## Cost-efficient manufacturing – remain competitive

Competition in the BCF carpet yarn market is intense. The answer to ever-increasing cost pressures is efficient BCF systems with optimized machine layouts and bespoke production processes.

### BCF S+ benefits:

- High production speed and high capacity
- System Efficiency of up to 99 %
- Economically efficient 3-end process
- e-save certified
- Multi-polymer capability
- Color Pop Compacting (CPC) for tricolor production\*

### BCF S8 benefits:

- Higher production speeds than ever before due to straight yarn path
- Highest production capacity by increasing throughput up to 15 %.
- System efficiency of up to 99%
- Economically efficient 3-end process
- Excellent yarn quality with best downstream performance and uniformity in the carpet
- e-save certified energy savings of up to 5% per kilogram of yarn compared to the BCF S+ (with RoTac<sup>3</sup>)
- Multi-polymer capability / BICO BCF
- Advanced CPC-T for flexible tricolor production and more than 200,000 color shades\*

\* This is an optional feature

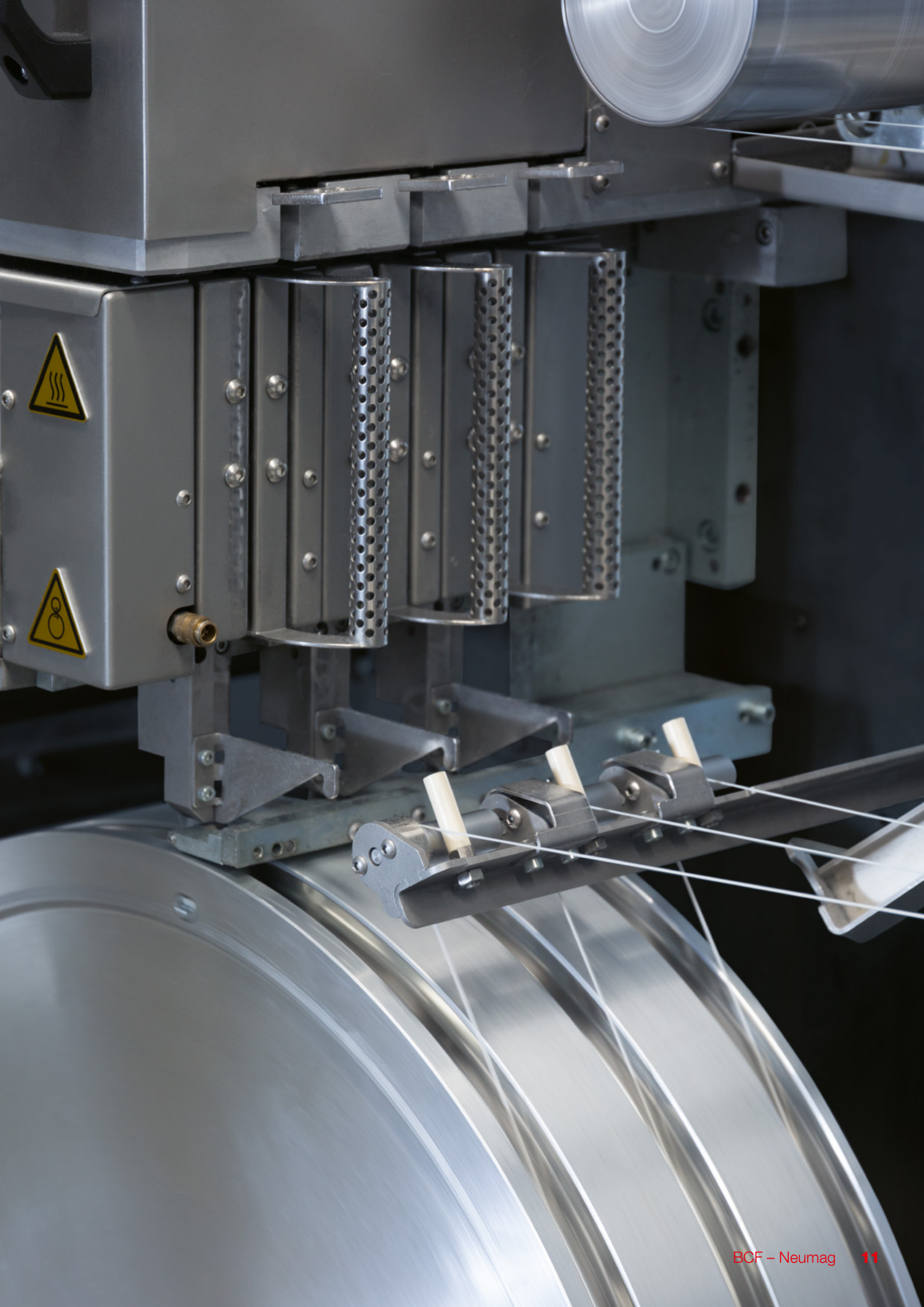

## BCF S+ – the brave companion at your side

Top performance and an ergonomic design make the BCF S+ a highly efficient BCF system from Neumag. Lots of smart innovations make the difference.

- 1 Variomelt for tricolor production\*
- 2 Approved metering units
- 3 Energy efficient extrusion systems
- 4 Fully incorporated spinning beam
- 5 Take-up unit with proven technology and components
- 6 Tangling with RoTac<sup>3\*</sup>
- 7 Winder Witras III-34 for process speeds up to 3400 m/min
- 8 Color Pop Compacting (CPC) for tricolor production\*

\* This is an optional feature



**BCF S+ infos**

### BCF S+ plant specifications

<b>Polymer types</b>	PP, PA6, PET
<b>Machine configurations</b>	Mono 1x2, 2x2, 3x2, 1x4, Trico 1x3, 2x3
<b>Process</b>	Monocolor and Tricolor
<b>Number of positions</b>	Mono 2, 4, 6, Trico 3, 6
<b>Ends per position</b>	3-end
<b>Max. no. of filaments</b>	Mono 400, trico 402
<b>Titer range*</b>	Mono 600 - 4000 dtex, Trico 900 - 4000 dtex

\* Titer range depends on polymer and number of filaments.

<b>Dosing system</b>	Gravimetric
<b>Dpf range <sup>a)</sup></b>	PP 4 - 50 dpf, PA6 8 - 40 dpf, PET 4 - 30 dpf
<b>Max. winder speed</b>	Witras III-34 3400 m/min.
<b>Max. bobbin diameter</b>	320 mm
<b>Pitch</b>	Mono 2000 mm, Trico 2200 mm
<b>Spinning height</b>	PP 6.5 m, PA6 7.5 m, PET 7.5 m
<b>Max. plant height</b>	PP 11 m, PA6 and PET 12 m

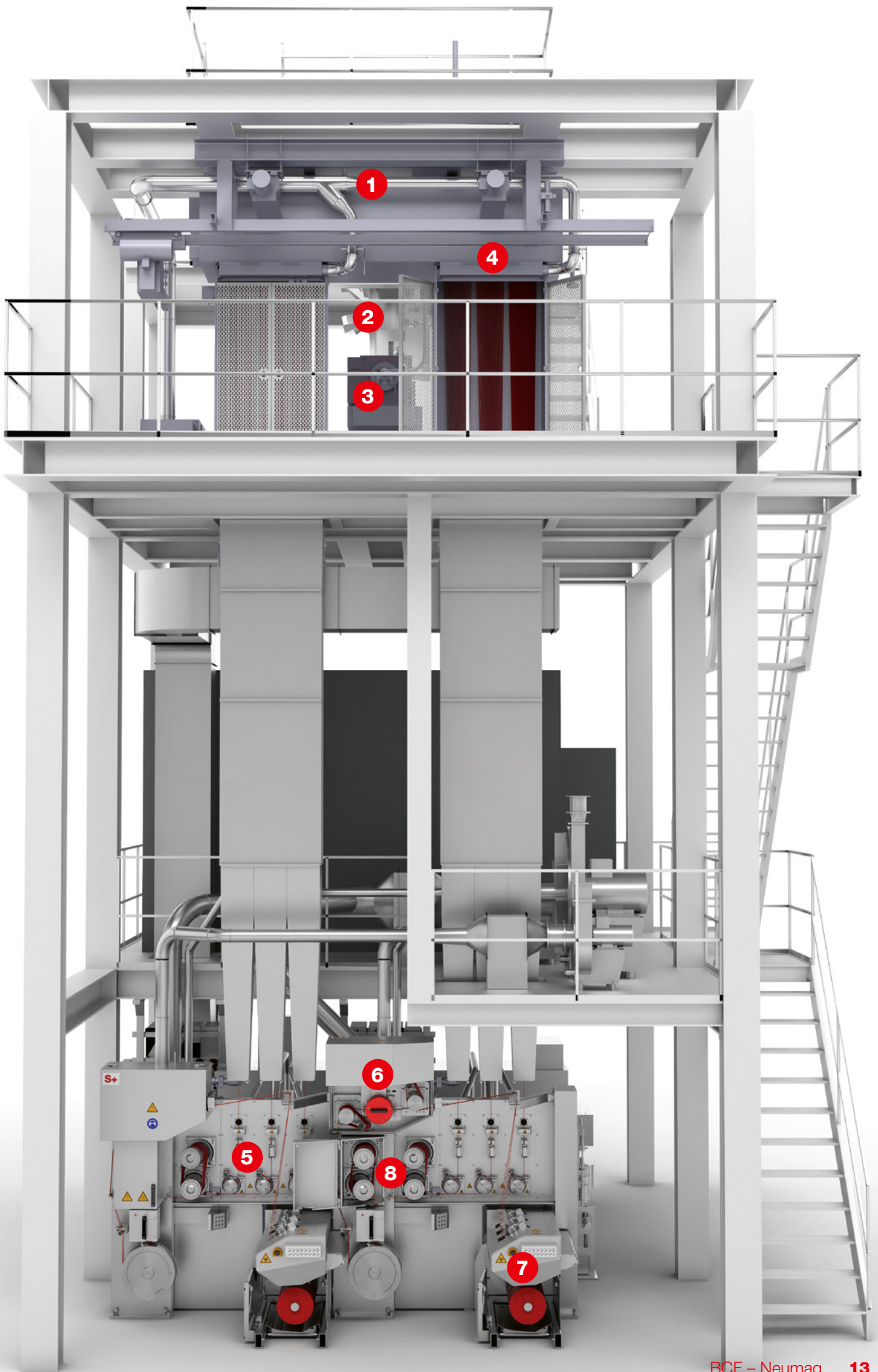

## BCF S+ machine design

The BCF S+ is the proven and world-leading BCF plant.

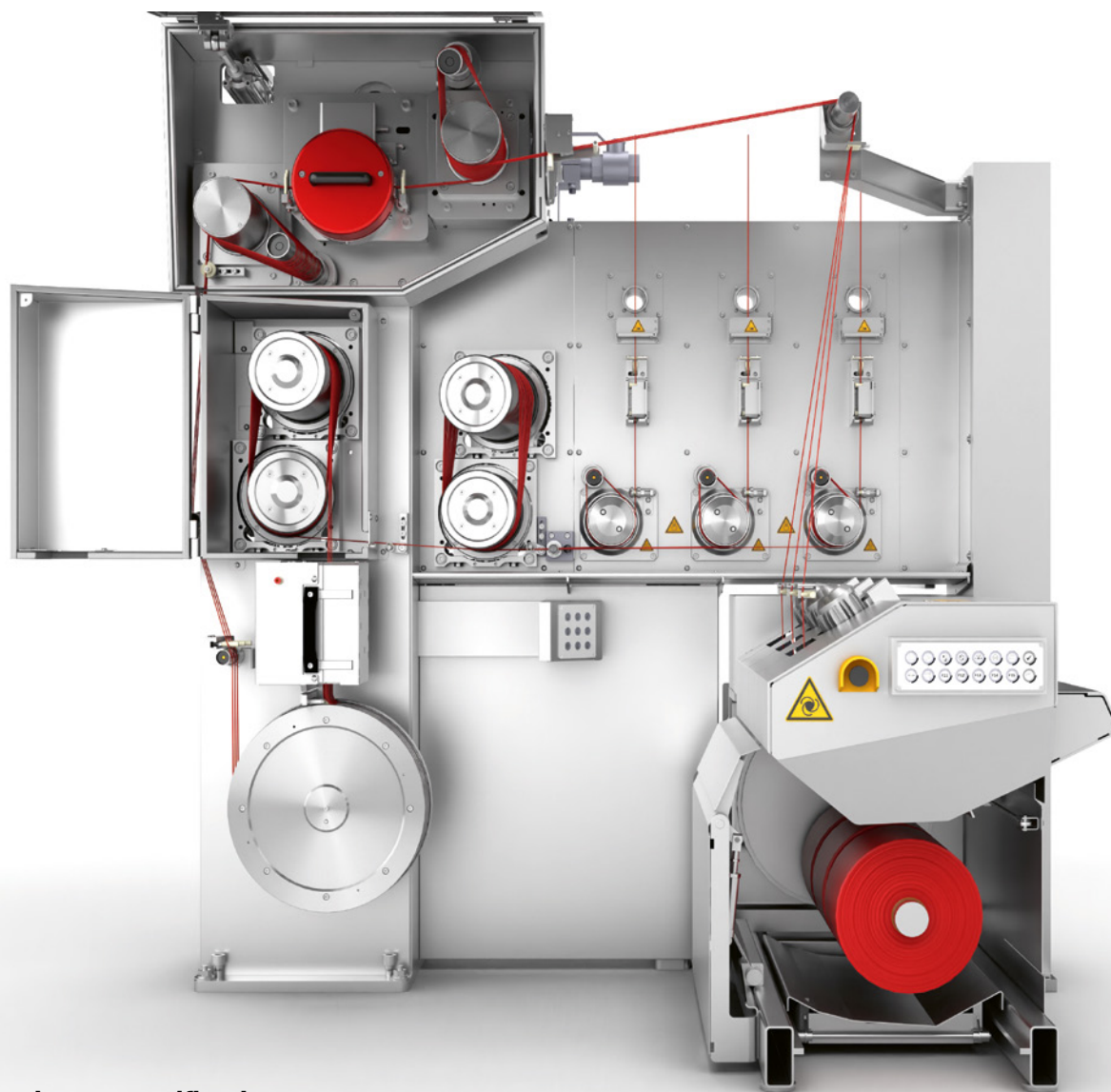

### BCF S+ take-up specifications

<b>Number of heated godets</b>	PP: 3, PA6: 3 or 4, PET: 4 + 3 SIG*
<b>Heating zones main godets</b>	6
<b>Heating principle of main godets</b>	induction
<b>Lubrication sys. of heated godets</b>	oil-air-circulation
<b>Variomelt</b>	option
<b>Cam roll for tricolor</b>	option

\* Single Infeed Godet

<b>CPC for tricolor</b>	option for PP and PET (max. 2700 dtex)
<b>Texturing system</b>	Friction
<b>Cooling drum diameter</b>	480 mm
<b>Cooling drum cross-section</b>	U-groove for PP, V-groove for PA6 and PET
<b>Tangling unit</b>	Temco Tandem, RoTac <sup>3</sup> (optional)
<b>Min. winder speed</b>	1800 m/min (with limited bobbin diameter) 2000 - 3400 m/min

### 1. Variomelt for tricolor production

Variomelt is a tricolor BCF plant equipped with a melt flow changing device. It offers the flexibility to produce tricolor or three different color monocolour BCF yarn products.

### 2. Approved metering units

The gravimetric system is equipped with one main component and two hoppers for additives such as masterbatch or UV stabilizer. We offer Doteco as a standard metering unit which has been proven worldwide for our BCF machines for many years.

### 3. Energy efficient extrusion systems

Extruders from Barmag are known not only for their high reliability but also for the best possible melting process. A special screw design ensures optimal homogenization of melt and masterbatch. In addition the excellent insulation and the high-quality drives guarantee high energy efficiency. A wide range of special screw designs for different polymers and polymer combinations are available to ensure maximum performance.

### 4. Fully incorporated spinning beam

The dowtherm system is fully integrated into the spinning beam and heated by flexible heating cartridges\*, minimizing temperature losses and eliminating the need for extensive boiler and piping installation.

The spinning beam design ensures a very homogeneous melt distribution. The temperature profiles of a system can be individually set for two positions.

The spin packs can be installed in and removed from the spinning beam by using the spin pack installation device.

\* Please note that due to country-specific regulations, this system cannot be applied in every country.

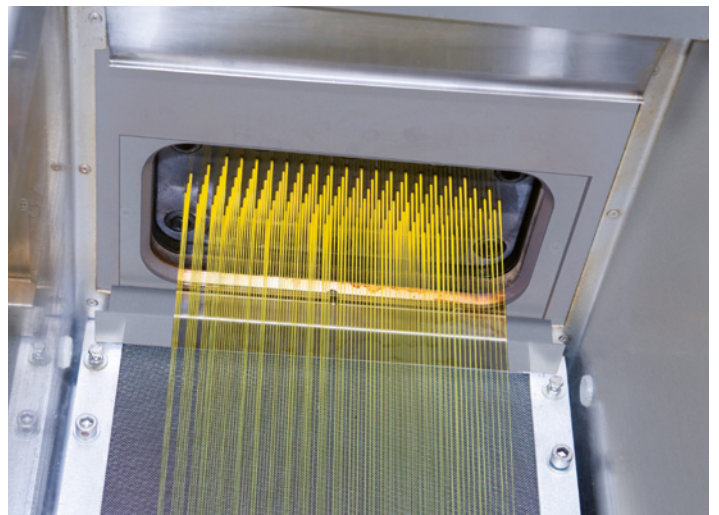

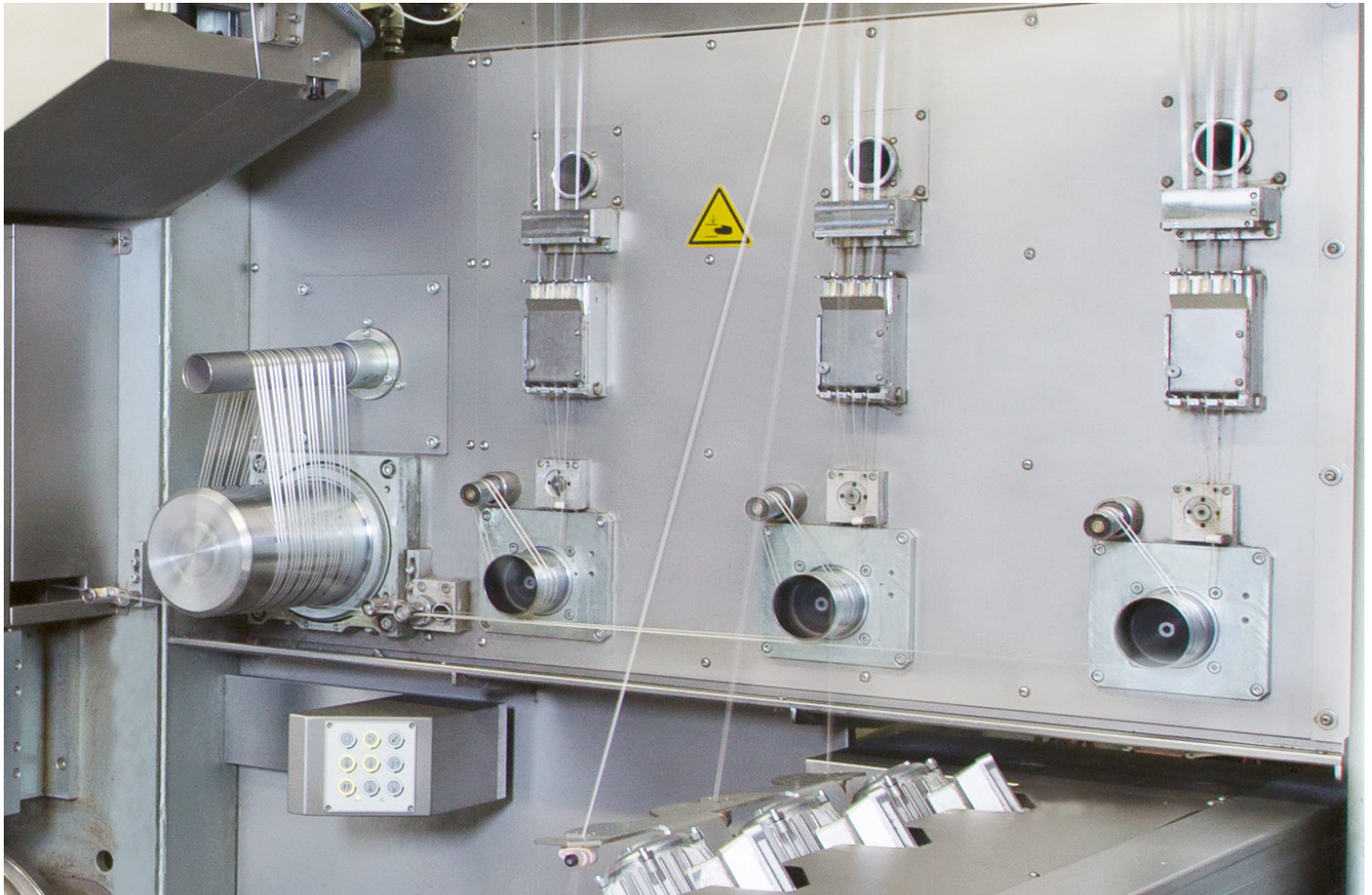

### 5. Take-up unit with proven technology and components

The BCF S+ take-up is the core of every plant, featuring a proven design with components that are finely tuned to meet the unique requirements of the BCF process. This proven design incorporates components optimized for the specific demands of the BCF process.

With the BCF S+, the width per position is 2 m for monocolour and 2.2 m for tricolor. The overall design makes handling much easier and more efficient.

The use of a steel structure for the machine frame reduces the overall depth of the machine, thus improving access to the rear of the machine for service and maintenance.

The BCF S+ also allows for the production of different yarn qualities on each position. The pressures for the aircover, yarn exhaust, pre-tangling, texturing, and tangling can be adjusted individually (either electronically or mechanically), offering greater flexibility and control.

## 6. Tangling with RoTac<sup>3</sup> available

The BCF S+ can be either equipped with a conventional continuous air flow tangling unit or upgraded with our highly beneficial RoTac<sup>3</sup> rotary tangling unit.

## 7. Witras winder III-34 for process speeds up to 3400 m/min

Based on more than 30 international patents, the development of the Witras III winder was designed to meet numerous customer requirements for a reliable and advanced winder.

For the BCF S+, we have further developed our proven wing traversing winder. The new Witras III-34 winder uses one direct drive for each pair of wings. The essential yarn catching mechanism has been further improved. Friction of the yarn on the paper tube has been eliminated. The inverters are installed in the air-conditioned central cabinet to protect them from heat, airborne contaminants and spin finish.

In addition, the Witras III has improved movable shields to protect operators and bobbins during production while allowing for easier tube handling.

## 8. Color Pop Compacting (CPC) for tricolor production

The BCF S+ CPC is a method of color separation in a multicolor BCF process that raises the level of color separation, increases flexibility and lowers the overall capital and operating costs for these products.

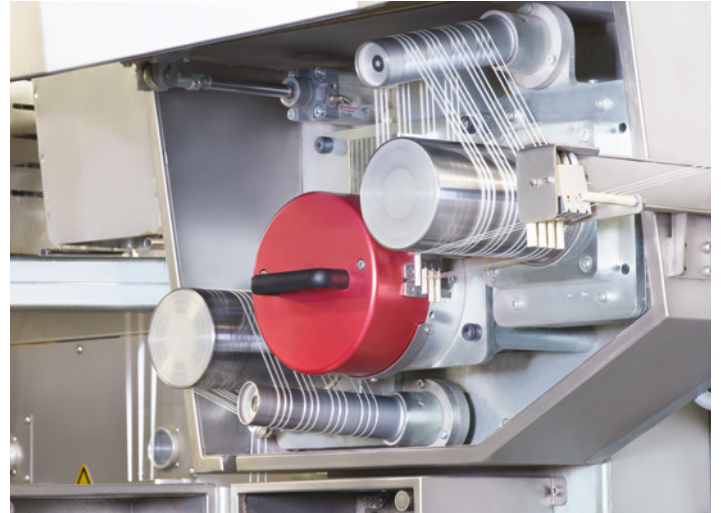

## BCF S8 – the trailblazer for high quality yarns

Future-oriented development steps make the BCF S8 the most efficient Neumag BCF system. Many smart innovations make the difference.

- 1 Optimized monocolour spin pack design with increased width for up to 700 filaments
- 2 Absolute straight yarn path from infeed through to cooling drum
- 3 Short distance between godet duo and texturing head reduces compressed air consumption
- 4 Removable texturing units for easy handling and protection of lamella chambers
- 5 Large cooling drum for higher retention time and improved carpet appearance
- 6 Advanced CPC-T for flexible tricolor production of all polymers
- 7 RoTac<sup>3</sup> enables perfect tangling results and saves energy
- 8 Winder Witras III-37 for process speeds of up to 3670 m/min
- 9 HMI for intuitive operation and take-up touch screen for smart and easy operation



BCF S8 infos

### BCF S8 plant specifications

<b>Polymer types</b>	PP, PA6, PET
<b>Machine configurations</b>	Mono 1x2, 2x2, 3x2, 1x4, Trico 1x3, 2x3
<b>Process</b>	Monocolour and Tricolor
<b>Number of positions</b>	Mono 2, 4, 6, Trico 3, 6
<b>Ends per position</b>	3-end
<b>Max. no. of filaments</b>	Mono 700, Trico 402
<b>Titer range*</b>	Mono 600 - 4000 dtex, Trico 900 - 4000 dtex

\* Range depends on polymer and number of filaments.

<b>Dosing system</b>	Gravimetric
<b>Dpf range*</b>	PP 2.5 - 50 dpf, PA6 3 - 40 dpf, PET 2.5 - 30 dpf
<b>Max. winder speed</b>	Witras III-37 3700 m/min.
<b>Max. bobbin diameter</b>	320 mm
<b>Pitch</b>	Mono and Trico 2200 mm
<b>Spinning height</b>	PP and PET 6.5 m, PA6 7.5 m
<b>Plant height</b>	PP and PET 12 m, PA6 13 m

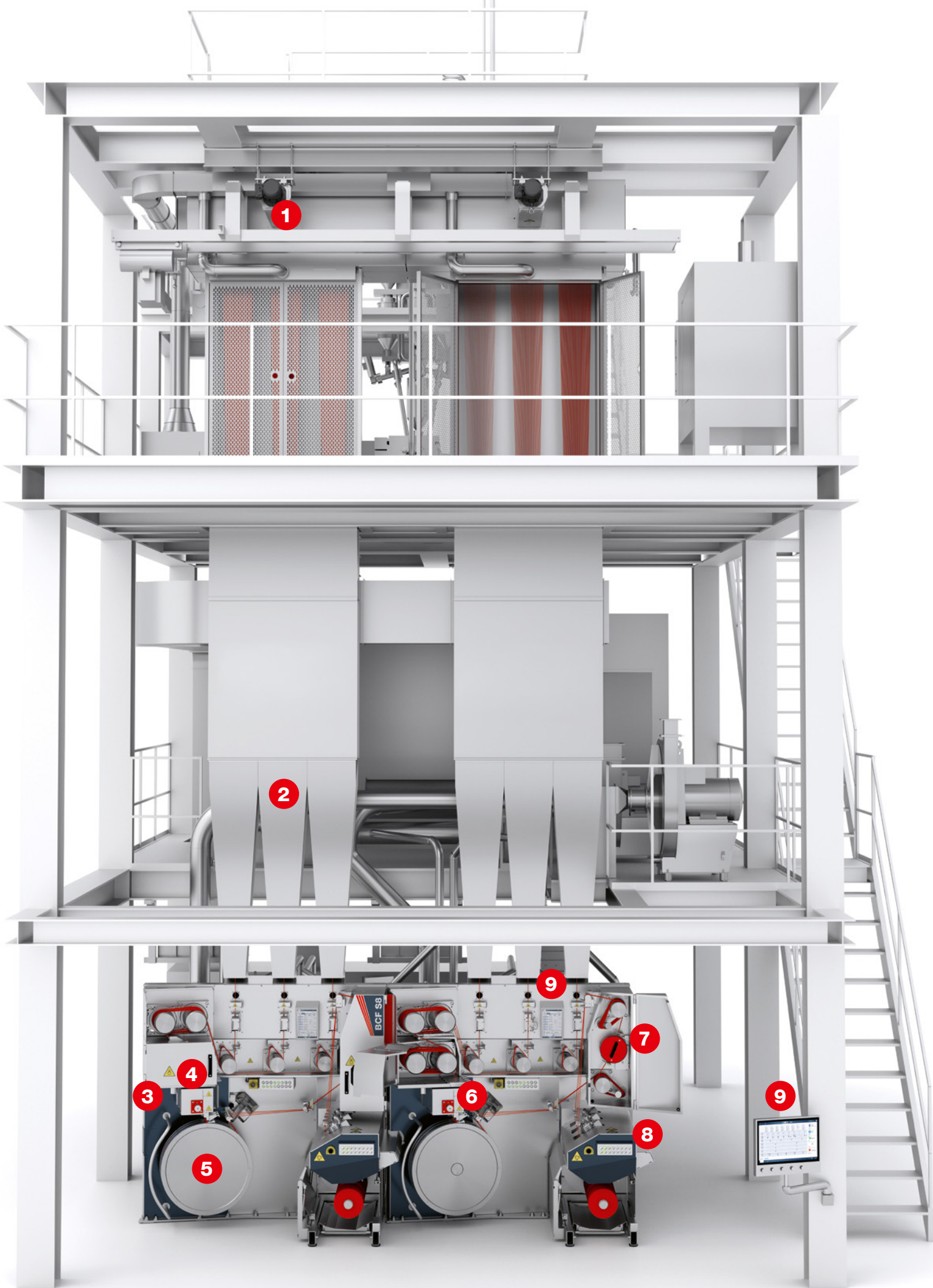

## BCF S8 smart innovations

The BCF S8 is the most efficient Neumag BCF system.



### BCF S8 take-up specifications

<b>Number of heated godets</b>	4
<b>Heating zones main godets</b>	6
<b>Heating principle of main godets</b>	induction
<b>Lubrication sys. of heated godets</b>	oil-air-circulation
<b>Variomelt</b>	option
<b>Cam roll for tricolor</b>	option

<b>CPC-T for tricolor</b>	option for PP, PET and PA6 (max. 3000 dtex)
<b>Texturing system</b>	Friction
<b>Cooling drum diameter</b>	800 mm
<b>Cooling drum cross-section</b>	V-groove
<b>Tangling unit</b>	RoTac <sup>3</sup>
<b>Min. winder speed</b>	Witras III-34 2000-3400 m/min (with limited diameter) Witras III-37 2400-3700 m/min (with limited diameter)

### **1. Optimized monocolour spin pack design with increased width enabling up to 700 filaments\***

Our monocolour spin packs are optimized for high speed processes, ensuring the best cooling performance of each individual filament.

\*New spin pack design. Not compatible with old design.

### **2. Absolutely straight yarn path from infeed to cooling drum by sequential threading**

A straight yarn path is the basis for a stable high-speed process. That is why we have designed the spinning system with a spinning angle of practically zero degrees – even with three ends per position. This guarantees a perfect yarn treatment right from the start.

### **3. Short distance between godet duo and texturing head reduces compressed air consumption**

Absolutely straight yarn path into the texturing head. Shorter distance between hot rolls and texturing head. Lower texturing pressure results in energy savings. Consistent yarn quality improves downstream performance

### **4. Removable texturing units for easy handling and protection of the lamella chambers**

The original Neumag texturing system for producing high bulk and yarn volume ensures excellent carpet coverage. The plants are supplied as standard with our vacuum texturing system, which is very robust and easy to adjust for a long-term trouble-free operation.

The advantages of Neumag texturing systems are an exceptionally long life, easy cleaning and maintenance. Each individual nozzle or lamella can be replaced if necessary. As an option, you can choose Neumag cermet lamellas which have a high resistance to bending and a better hardness compared to ceramic lamellas, resulting in a higher wear resistance.

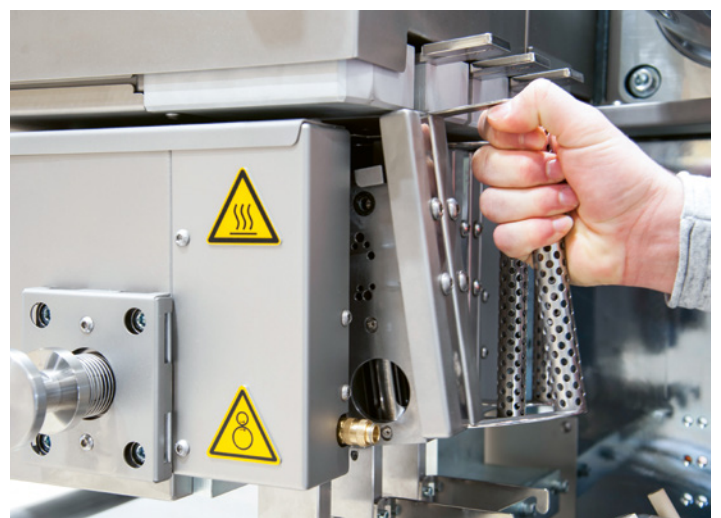



### 5. Large cooling drum with V-groove

Optimum dwell time and cooling of the yarn is ensured by an extremely large cooling drum with a diameter of 800 mm.

Constant yarn tension is even more important for the appearance of a multi-color carpet than for a single-color carpet, as stripes become more visible.

The BCF S8 cooling drum is equipped as standard with a V-groove for all polymers (PET, PA6 and PP) so that the plugs can always be laid straight. The yarn tension remains constant, loops are avoided and stripes in the carpet are avoided - improving the appearance of the carpet.

### 6. Innovative CPC-T for tricolor production

The BCF S8 CPC-T has not only been redesigned, it has also been moved to a new location directly above the texturing head. For the operator, this means much better access and simplified threading. The process is faster and more stable.

And when production needs to be switched from tricolor to monocolour yarns, the BCF S8 CPC-T can be effortlessly replaced with the monoguide.

### **7. RoTac<sup>3</sup> delivers perfect tangling results and saves energy**

The RoTac<sup>3</sup> rotary tangling unit provides energy-efficient, highly uniform tangling at high speeds. The tangle knots are created by a discontinuous pulse of compressed air. Compared to conventional tangling units with continuous air flow, compressed air consumption is reduced by up to 50%, depending on the yarn type.

### **8. Winder Witras III-37 for winder speeds of up to 3700 m/min**

The BCF S8 can use either the Witras III-34 or the Witras III-37, which is capable of winding speeds up to 3700 m/min, enabling the high production output of the BCF S8.

### **9. Modern human-machine interface for intuitive operation**

In the digital age, machine control systems are used for more than just human-machine communication. They also play a key role in increasing machine and workflow efficiency.

With a sleek new design, the BCF S8 combines intelligent features and advanced logic to streamline and enhance your daily workflow.

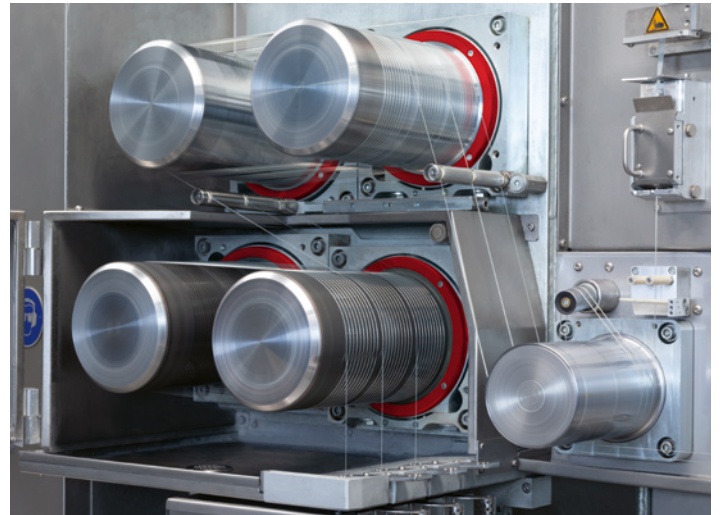

## Multicolor production

Variomelt is a tricolor BCF plant equipped with a melt flow changing device. It offers the flexibility to produce tricolor or three different color monocolour BCF yarn products.

### Variomelt for tricolor production

The Variomelt system is integrated into the spinning beam. With Variomelt the plant can be converted from tricolor to monocolour operation. The close connection of the extruders to the spinning beam guarantees the shortest possible product lines and the lowest possible flushing losses during product changes. In combination with one extruder per position, it is attractive for small lots of monocolour yarns because the running times of the lots are increased, therefore the flushing losses during color change are reduced by 2/3rds.

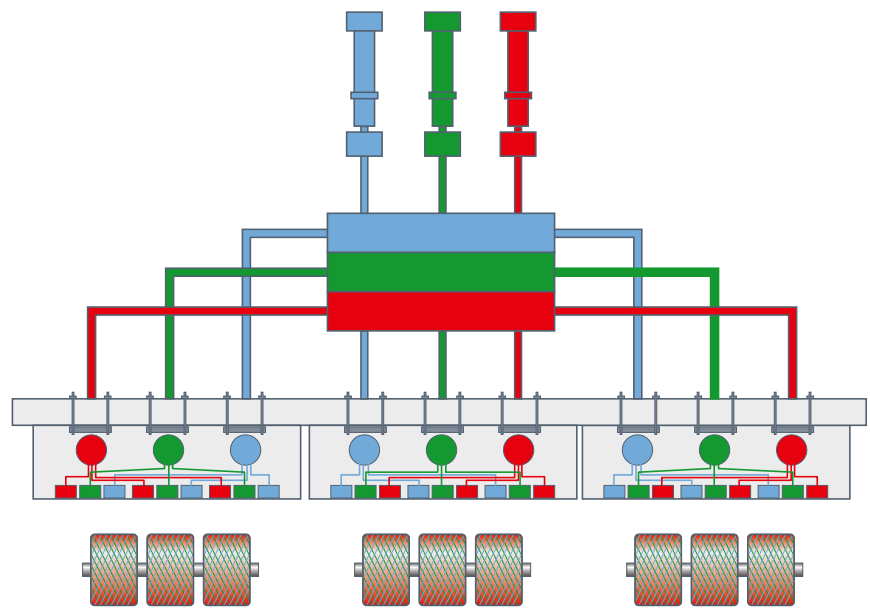

Tricolor production with a three-position spinning beam and three ends

### Cam rolls for tricolor production

The cam roll is located in the infeed section of the machine, between the Pre-interlace unit and the inlet godets. The cam roll is used in a three color machine to mix the 3 different yarn ends. The frequency of the mixing is adjustable, while the speed of the cam roll motor can be changed. The cam roll ensures a very even mixing effect for a uniform looking carpet where the colors do change in a certain pattern. It is an important parameter for the uniform appearance of your carpet.

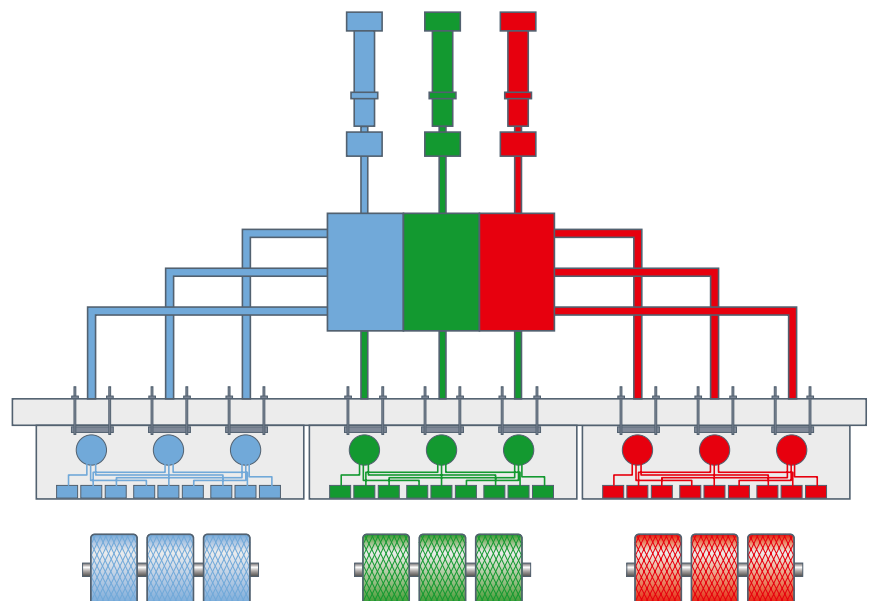

Monocolour production with three different colors, a three-position spinning beam and three ends

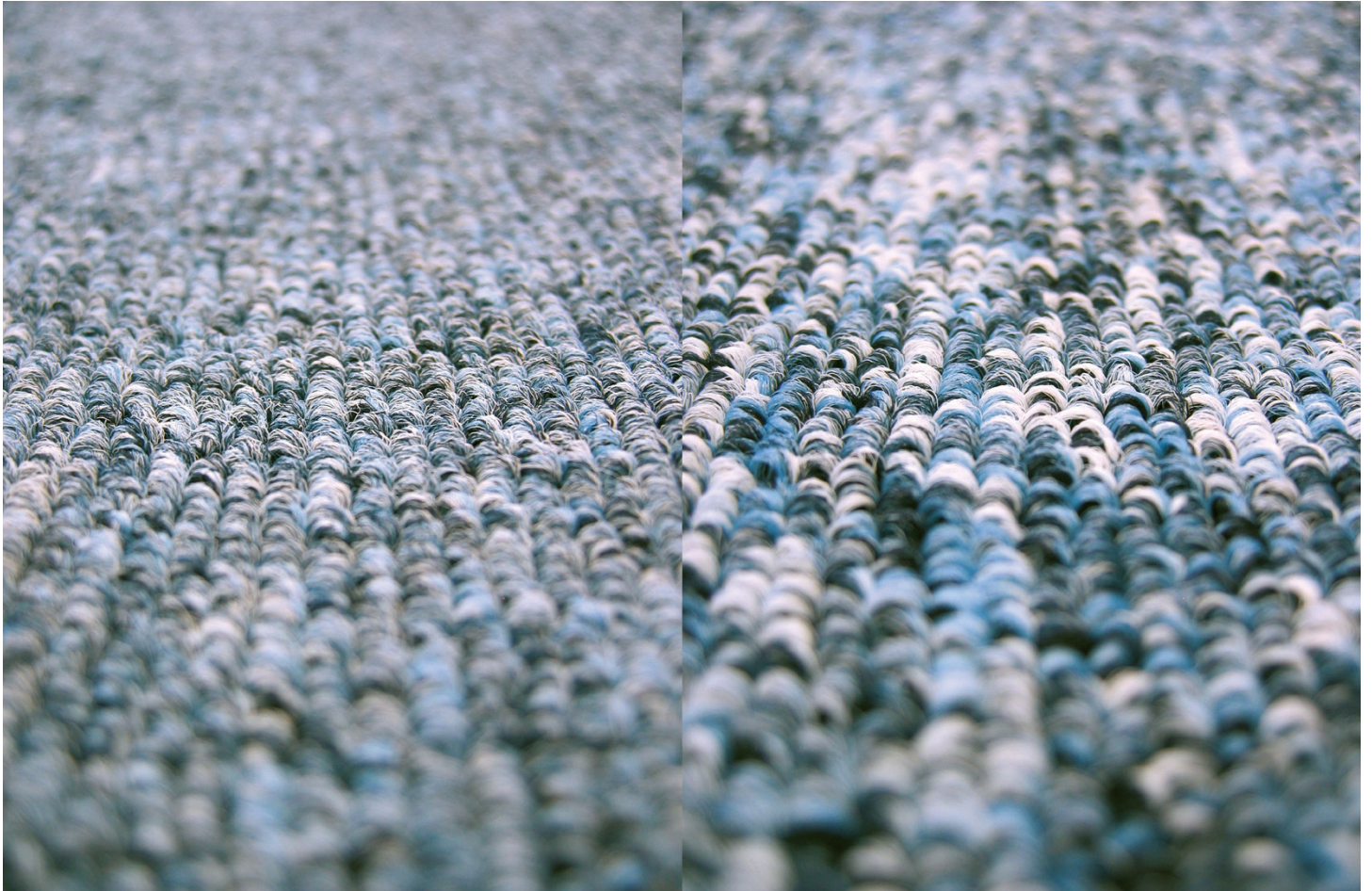

### **Color Pop Compacting for tricolor production**

CPC - Color Pop Compacting - is a method of color separation in a multicolor BCF process that raises the level of color separation, increases flexibility, and reduces the overall investment and operating costs for these products. When different levels of color separation are required, only the operating pressure of the CPC unit needs to be adjusted. The higher the set pressure (range approximately 2 - 8 bar), the more distinct the color separation (color pop). The colors run separately over the godet, are individually intermingled (tangled) in the CPC unit, and then run into a texturing nozzle. This makes it possible to use a standard texturing head.

## Color separation with BCF S8 and CPC-T

Multicolored carpets are becoming increasingly popular. There is a growing demand for much more flexible color mixing options. Our answer on this: Developing the BCF S8, a platform that enables the production of yarns with any degree of color separation - from mélange to highly separated colors.

At the heart of this process is the CPC unit for more flexible and consistent color separation. As shown in the photo below, the BCF S8 CPC-T unit is located directly above the texturing head. Each color is compacted immediately prior to texturing. This prevents unwanted merging of colors during texturing or the main blending process.

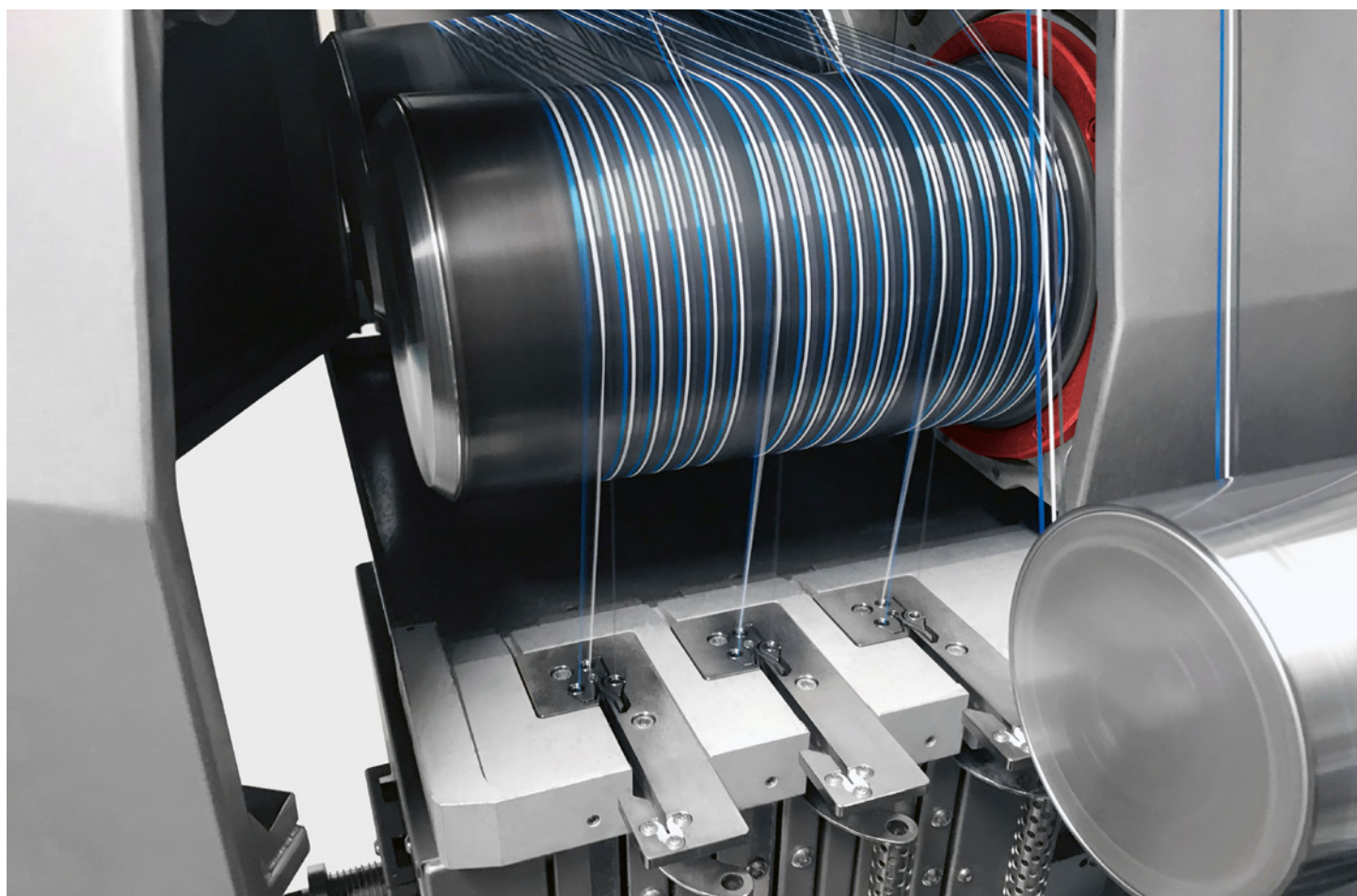

### **More than 200,000 different color shades from three colors**

The BCF S8 CPC-T allows the production of more than 200,000 different color shades – all from just three different colors. This is made possible by the individually controllable air pressures for each color, which can be set in a range of between 0 and 6 bar. In addition, individual colors can be reproducibly accentuated in the carpet – for a virtually unlimited variety of color patterns.

### **Completely redesigned CPC-T for easier accesibility**

The BCF S8 CPC-T has not only been redesigned, it has also been relocated directly above the texturing head. For the operator, this means much better access and simplified thread-up. The process is faster and more stable.

And when production needs to be switched from tricolor to monocolour yarns, the BCF S8 CPC-T can be quickly replaced with the monoguide.

### **Straight yarn path for more process stability and reliability**

The absolutely straight yarn path of the BCF S8 really comes into its own when producing tricolor yarn. Each filament is taken off the godets in exactly the same way and passes through the CPC-T and into the texturing head in a correspondingly uniform manner. This significantly improves yarn quality.

### **Color separation with CPC-T**



Mélange



Color pop



One color is highlighted

## RoTac<sup>3</sup>

### Versatile and energy-efficient tangling solution

RoTac<sup>3</sup> effectively prevents loops in BCF yarns during tufting and weaving, ensuring a consistent, uniform carpet appearance—particularly with tricolor yarns. As process speeds rise, the demand for reliable tangling increases, which can drive up compressed air consumption. RoTac<sup>3</sup> helps balance performance and cost-efficiency, providing the flexibility needed to adapt to varying production requirements while optimizing air usage.

#### Adaptability of airflow control

The RoTac<sup>3</sup> uses a discontinuous air blast that releases air only when needed. This method makes it possible to adjust the air-flow rate and energy consumption according to the yarn type and the specific requirements of the process. The flexibility here comes from the ability to reduce air consumption by up to 50%, which varies depending on the production requirements.

#### High production speed and constant knot control

The RoTac<sup>3</sup> can produce consistent tangle knots even at high production speeds, making it flexible in adapting to different production scenarios. This means that the process remains efficient and stable, even under varying production conditions.

#### Gentle yarn guidance for different yarn qualities

The RoTac<sup>3</sup> offers gentle yarn guidance that minimizes friction and thus ensures higher process stability. This flexibility is particularly useful when processing fine yarn tilters and sensitive materials such as brittle polymers.

#### Energy efficiency and environmental friendliness

RoTac<sup>3</sup> has been awarded the e-save label, indicating that it not only optimizes costs but also reduces energy consumption, thus offering sustainable and flexible use with regard to the environment. This combination of efficiency and environmental awareness offers users a flexible solution for reducing operating costs and energy consumption.

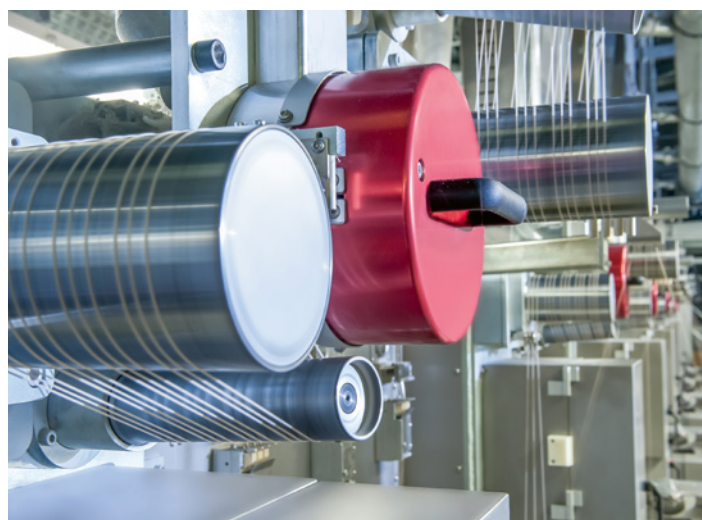

# BICO BCF

## Disruptive potential

BICO BCF side-by-side yarn is characterized by a higher crimp and a more voluminous appearance, which significantly reduces yarn consumption in carpet production, while at the same time giving the floor a much higher resilience. This unique combination makes it possible to manufacture carpets with a particularly rich look and outstanding feel – while simultaneously reducing production costs and the use of resources.

### Product flexibility with BICO BCF technology

With the BICO BCF technology and the right selection of polymers a very high crimp and resilience is achieved.

Neumag uses its production proven BICO BCF spinning technology to realize a completely new yarn. This yarn excels in carpets due to its good covering and extreme resilience.

### Advantages of BICO BCF yarn:

- Increase carpet performance with higher bulk.
- Approx. 20% less face fiber usage with the same carpet performance.
- Higher carpet resilience due to self recovery of crimp.
- Approx. 15% less raw material cost\* per kg by replacing PA6 with BICO BCF yarn.

\* Depending on the regional polymer prices.

### Applications:

- Contract carpets
- Automotive / Aviation carpets
- Residential carpets
- New BCF applications

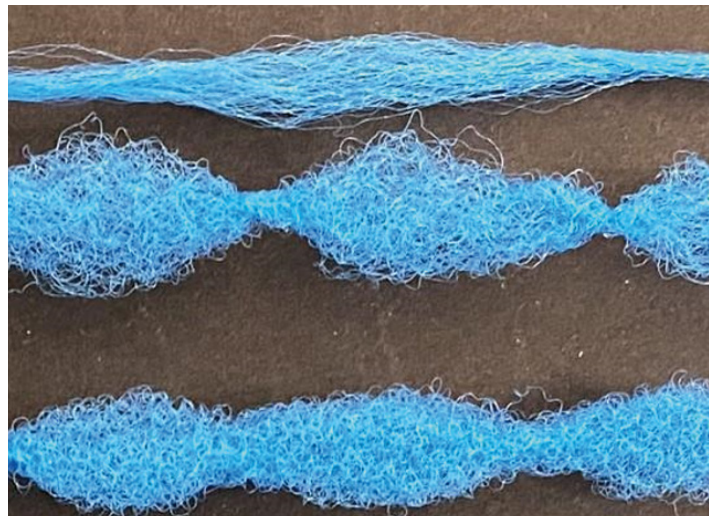

## Trendsetting human-machine interface for intuitive operation

In the digital age, machine control systems are used not only for communication between man and machine. They are also designed to decisively help increase machine and workflow efficiency.

Digitalization has finally also arrived for the human-machine interface in the BCF S8. In addition to a completely new appearance, smart features and logics simplify your everyday work.

### One HMI – five-fold benefit

- Intuitive, role-based operation
- Ideal summary of machine parameters due to contemporary user interface and look & feel
- Smart information at a glance
- Easy process analytics
- Easy troubleshooting

### Next-level human-machine communication

A completely new alarm philosophy has been developed to control the BCF S8. Subsequent errors are already suppressed in the PLC and are not transmitted to the HMI.

Sophisticated filter mechanisms and display options are used to swiftly provide an overview of the current or historical state of the system in the HMI. Additionally error analysis and searching have become considerably simpler.

### Take-up touch screen

Take-up touch screen is a further highlight that makes the most important information immediately accessible on the machine. Operating states, alarm notifications as well as actual and target values are directly available at all take-ups.

### Modular and future-proof

The new HMI system is modular in structure. Further intelligent functions are currently being developed.

### Secure Remote Services

When it comes to internet security, threats and security standards are constantly evolving. To stay ahead, these developments often necessitate cutting-edge hardware upgrades, which come with associated costs. Our IT experts closely monitor the latest security trends and updates on a daily basis, ensuring that your systems are always protected and up to date.

This solution enables proactive monitoring, regular updates, and quick responses to any emerging security risks, all without the need for significant upfront investments in hardware.

### Access & Analysis

Key Performance Indicators (KPIs) make it possible to measure machine performance and react quickly to deviations. Economic success can be maintained or further improved by optimizing machine operation.

The Access & Analysis package provides you with reliable data directly from the machine, including the automatic calculation of relevant KPIs that allow specific conclusions to be drawn about machine performance.

### CPU Extension

The CPU is at the heart of every company communication system. The BCF S8 features a next generation CPU designed for improved performance and increased storage. Its advanced Flash-Eprom securely stores the latest software, ensuring seamless recovery in case of failure, including electrical diagrams and documentation. If a program fails, personnel can quickly reload the CPU program, minimizing downtime and restoring full production.

NEUMAG BCF technology John Doe 21/04/18 13:30:00

BCF S8

Utilities	Compressed Air	Fan	Chiller	Air Condition	Silo
Dryer					
Metering					
Extruder					
Spinning					
Take Up					
Winder					

Information	MP 34-01	MP 34-02	MP 34-03	MP 34-04	MP 34-05	MP 34-06	MP 34-07	MP 34-08
	33:41:12	33:41:12	33:41:12	33:41:12	33:41:12	33:41:12	33:41:12	33:41:12
	98,2 %	98,2 %	98,2 %	98,2 %	98,2 %	98,2 %	0,0 %	66,1 %
	12 / 01	12 / 01	12 / 01	12 / 01	12 / 01	12 / 01	- / -	12 / 01
	1st	1st	1st	1st	1st	1st	- / -	1st

Alarms

**X** Position 6 Godet 3 Drive: Motor overtemperature

KPI

**→** 99,4 %

Tasks

To Do 1  
To Do 2  
To Do 3

Trends

Trend 1

Products

BCF 1400dtext 500f  
80%

ENG

NEUMAG BCF technology John Doe 21/04/18 13:30:00

BCF S8 Extruder 1 Overview

Production - Basic

Metering 2	Met. Rate	Polymer	Add. 1	Add. 2	Add. 3
	000,00 %	000,00 %	000,00 %	000,00 %	000,00 %

Extruder 2	Drive	00000 A	00000 %/A	00000 KW	00000 %/KW	00000 rpm	00000 %/rpm
	Heating	Zone 1	Zone 2	Zone 3	Zone 4	Zone 5	Zone 6
		000,00 °C	000,00 °C	000,00 °C	000,00 °C	000,00 °C	000,00 °C
	Mess. Head	00,000 %	000,00 %	000,00 %	000,00 %	000,00 %	000,00 %
	Melt	000,00 °C	000,00 bar				

Melt Pipe	Zone 1	000,00 °C
-----------	--------	-----------

Screen Changer	Zone 1	000,00 °C	Pressure	Before	Behind
				000,00 bar	000,00 bar

Melt Pipe	Zone 1	000,00 °C
-----------	--------	-----------

Spinning Beam 2	Heating	000,00 °C	Position 1	Position 2
	Melt	000,00 bar	000,00 bar	000,00 bar
	Spin. Pump	000,00 rpm	000,00 rpm	000,00 rpm
	Melt	000,00 bar	000,00 bar	000,00 bar

Alarms

**X** Zone 3: Heating fault

KPI

**→** 100 %

Tasks

To Do 1  
To Do 2  
To Do 3

Trends

Trend 1

Products

No information

ENG

NEUMAG BCF technology John Doe 21/04/18 13:30:00

BCF S8 Position 3

Production - Basic

Production

- Basic
- All
- Yarn Tension
- Fans
- Drives Current

Controller

- Basic

Setup

- Basic

Speed	actual	production
Spinning Pump	000	000 rpm
Spinfinish	000	000 rpm
Inlet Godet	000	000 m/min
Pre Draw	000	000 m/min
Main Draw	000	000 m/min
Texturizing	000	000 m/min
Cooling Drum	000	000 m/min
Draw Off 1	000	000 m/min
Rotac	000	000 m/min
Draw Off 2	000	000 m/min
Winder	000	000 m/min

Temperature	actual	production
Pre Draw	000	000 °C
Main Draw	000	000 °C
Texturizing	000	000 °C

Pressure	actual	production
Inlet Godet	000	000 bar
Texturizing	000	000 bar
Rotac	000	000 bar

Production Mode

Alarms

**X** Godet 3 Drive: Motor overtemperature

KPI

**→** 99,4 %

Tasks

To Do 1  
To Do 2  
To Do 3

Trends

Trend 1

Products

BCF 1400dtext 500f  
80%

direct block

ENG

# Partnering for Performance

Our Customer Services department has one all-embracing mission: we want to make your production increasingly-efficient and productive, and your business increasingly competitive and profitable. To do this, we offer you a close working relationship – partnering for performance.

## **Our services for your success**

Textile technologies are becoming ever more efficient and flexible, opening up great opportunities to enhance your competitiveness. At the same time, this progress accelerates the race in the market. To be able to keep up and react swiftly to changing market situations, it is important to maintain and expand your technical capabilities and to utilize them properly.

To achieve these, we place emphasis on a close, trusting service partnership with you to ensure reliable production and gain a technological edge, to secure your investment and to guarantee success in the future. Together, let us exploit the strengths of our technologies for your business.

## **Our goal: your operational efficiency**

Through our partnership, we want to increase your operational efficiency to the best effect. With this in mind, we focus on optimizing your operating and manufacturing processes, your system and logistics management and the acquisition of further skills by your staff. Your success grows with the interplay of all the factors involved.

**Further information on our comprehensive Customer Service can be found here**

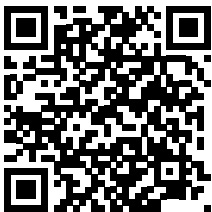

**Or contact us:**  
**[customer-services.neumag@barmag.com](mailto:customer-services.neumag@barmag.com)**

For this, we offer you the performance of a technology leader with a unique global service network, along with highly-qualified service and engineering experts. We will advise and support you in all phases of your business along the entire value creation chain of fiber production:

- With start-up services for the installation or relocation of your systems,
- With technical support around the clock,
- With modern services for maintenance and repair, performance enhancement and staff training,
- With longterm maintenance contracts for a continuously troublefree systems performance,
- With individual performance checks for an optimized plant operation, and
- With modernization and upgrades from the manmade fiber specialist.

Neumag is also the new customer service and spare parts contact for installed Truetzschler carpet and industrial yarn systems. Whatever you need, you can select services tailored to those requirements from a service portfolio that is unique in the industry.







## Our promises

With our Barmag and Neumag competence brands, we are the world market leader for manmade fiber filament spinning systems, texturing machines, BCF systems, staple fiber systems and nonwovens. As a service provider for engineering and aftersales services, we offer total solutions for the entire textile value added chain. We attach great importance to energy efficiency and sustainable technologies in all our developments.

To what extent do you profit from this? Our market position guarantees you the benefits and quality of leading technologies, our sustainable products save you money and our comprehensive services save you time and hence increase your profit.

**More on Neumag  
BCF solutions**



**Or contact us:  
[sales.neumag@barmag.com](mailto:sales.neumag@barmag.com)**

